

LIST 5

a)

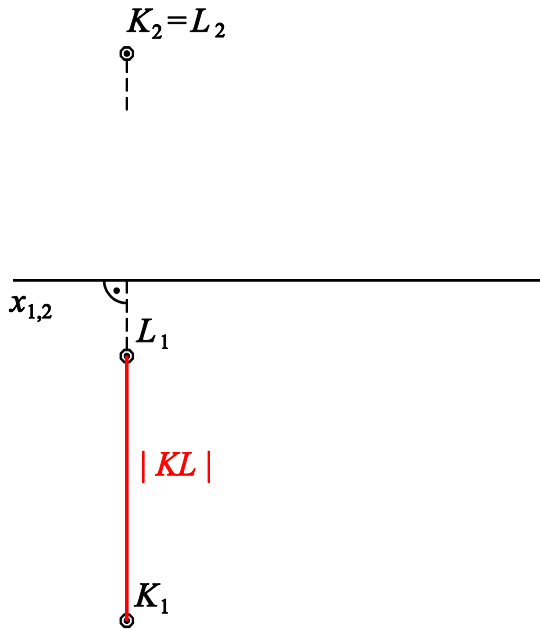

b)

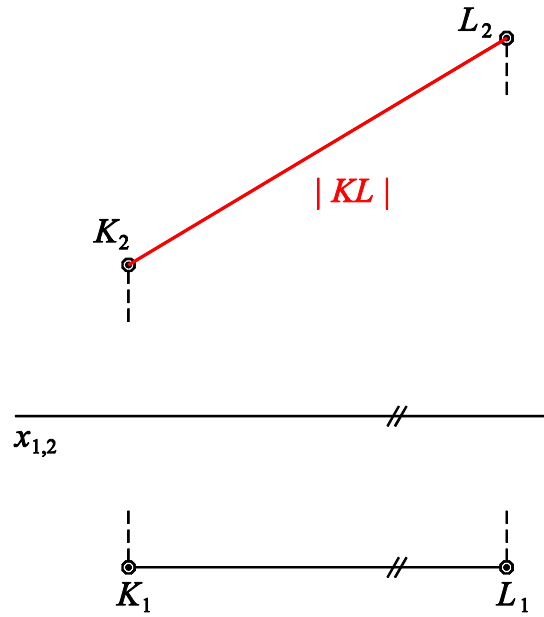

c)

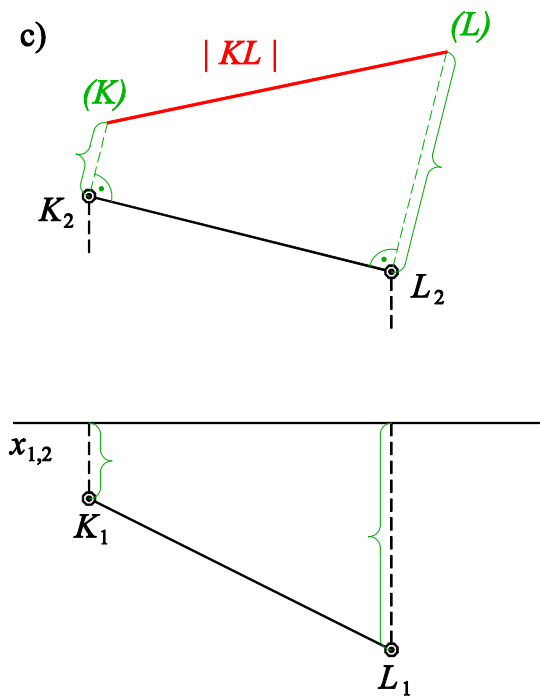

d)

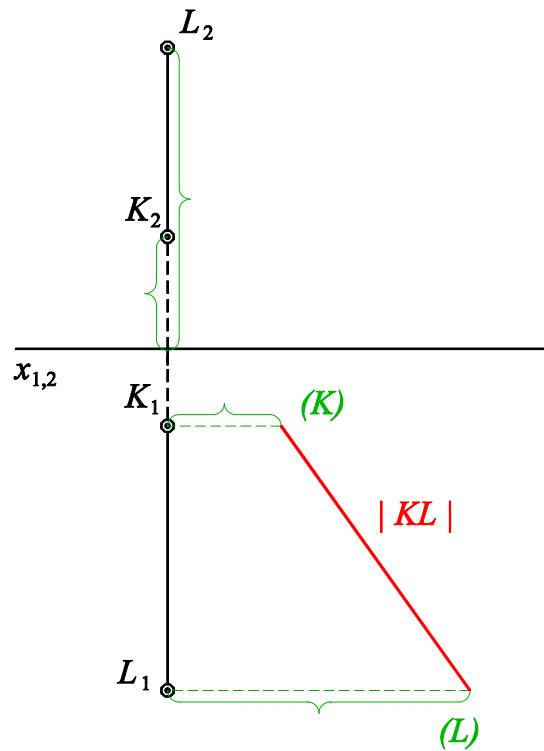

LIST 6

b)

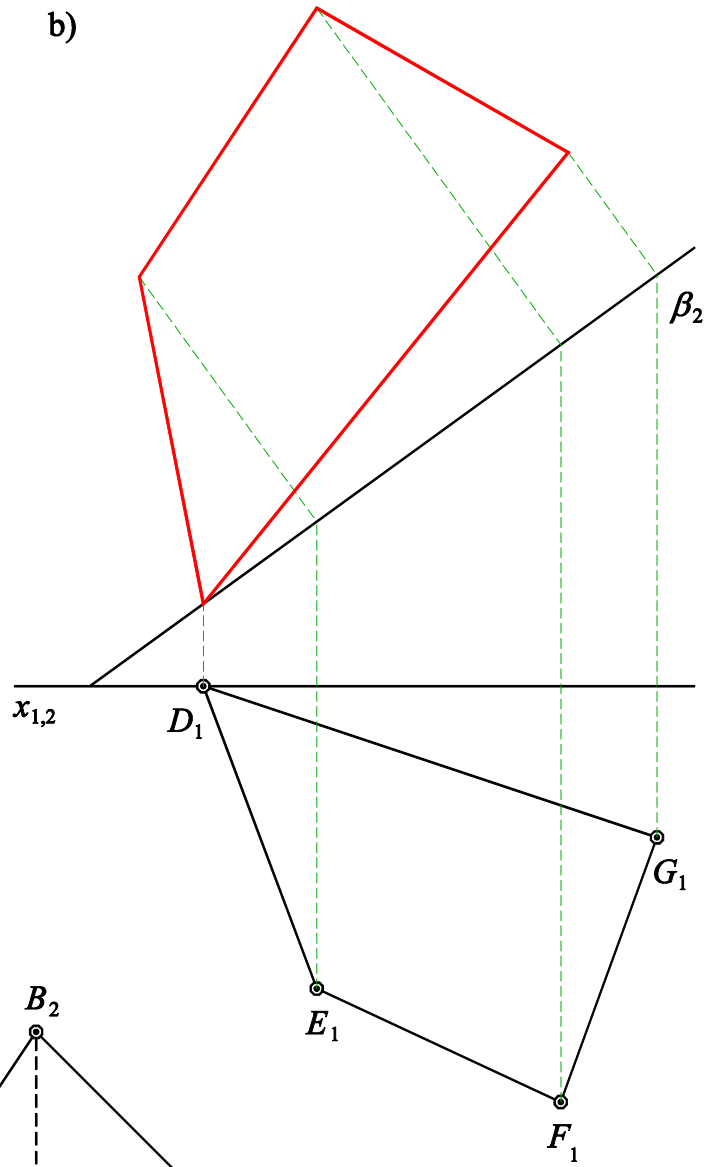

a)

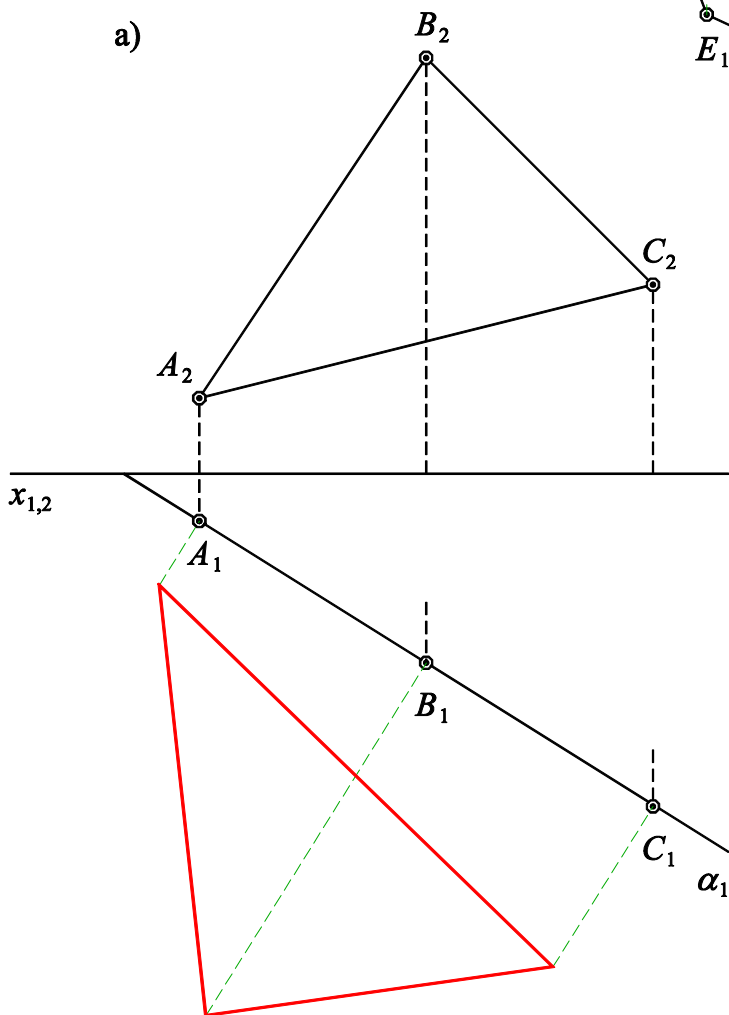

LIST 8

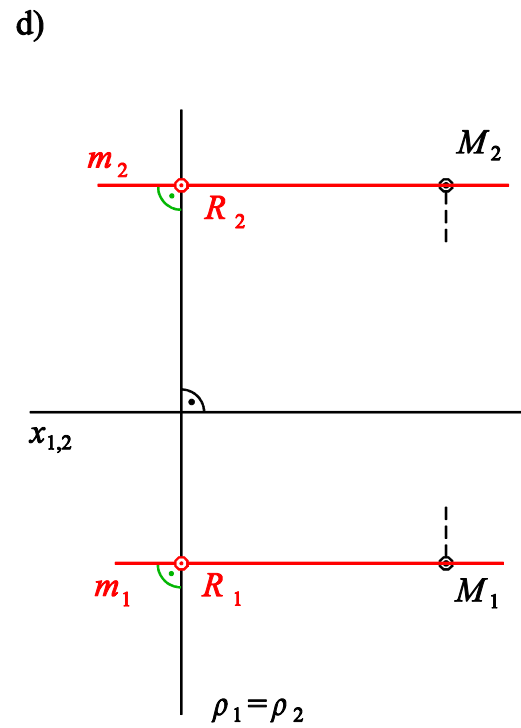
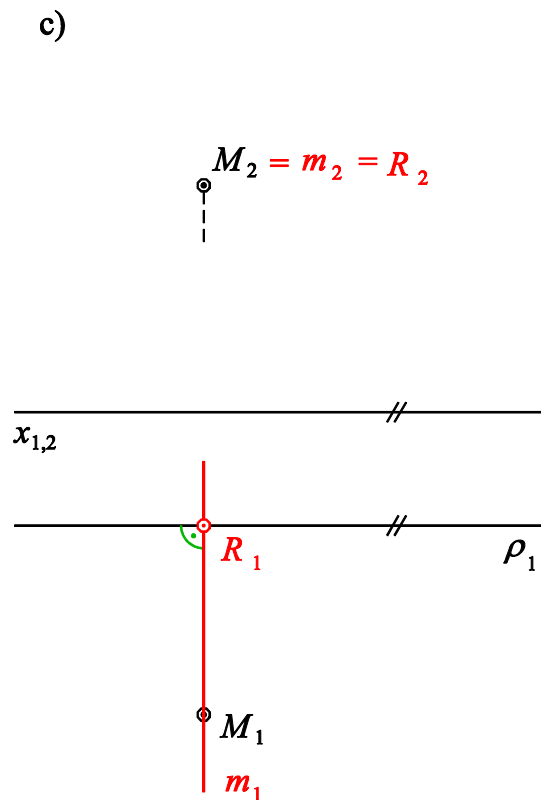
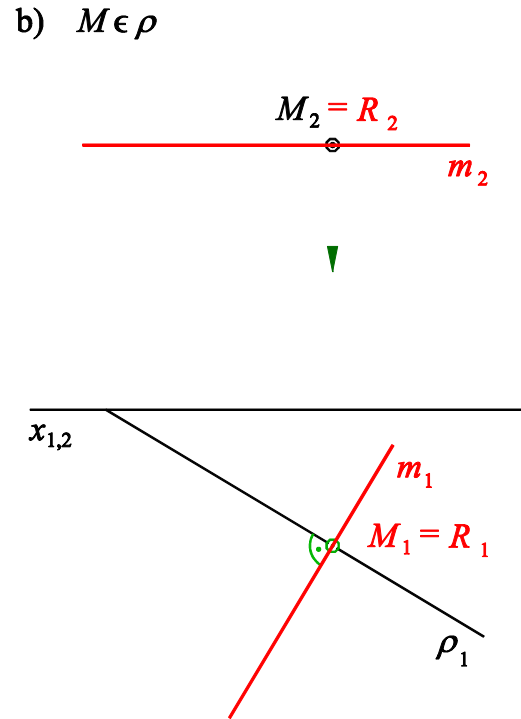
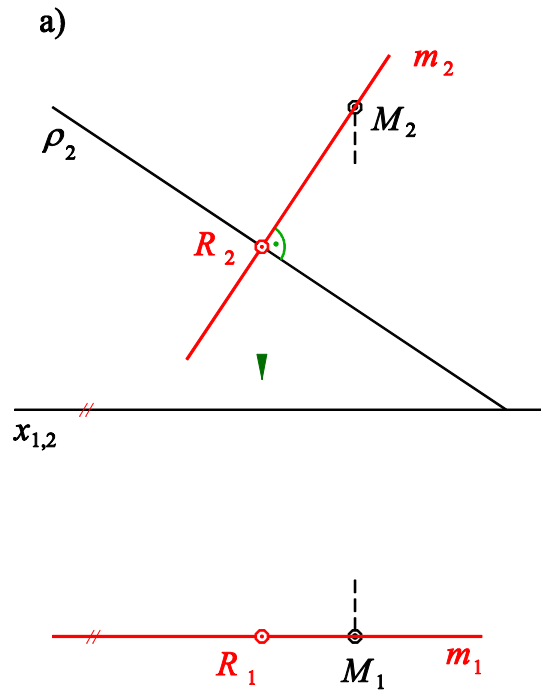

LIST 9

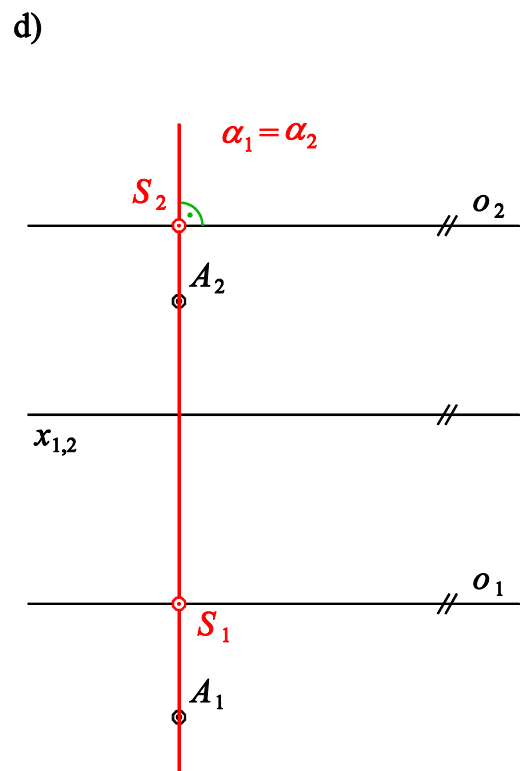
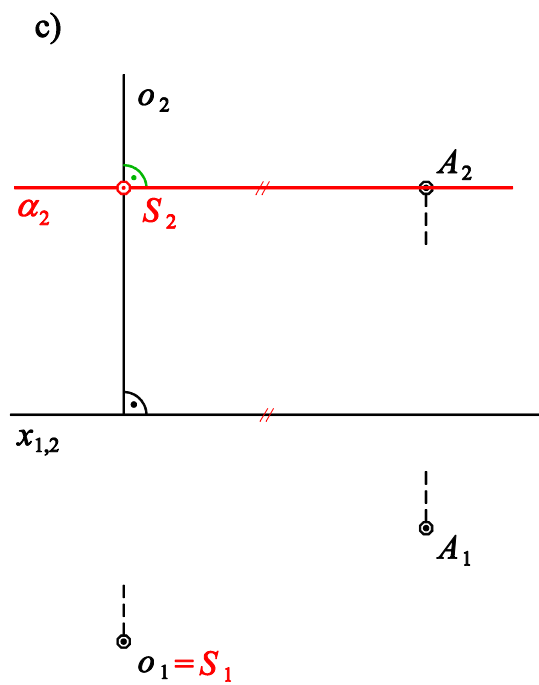
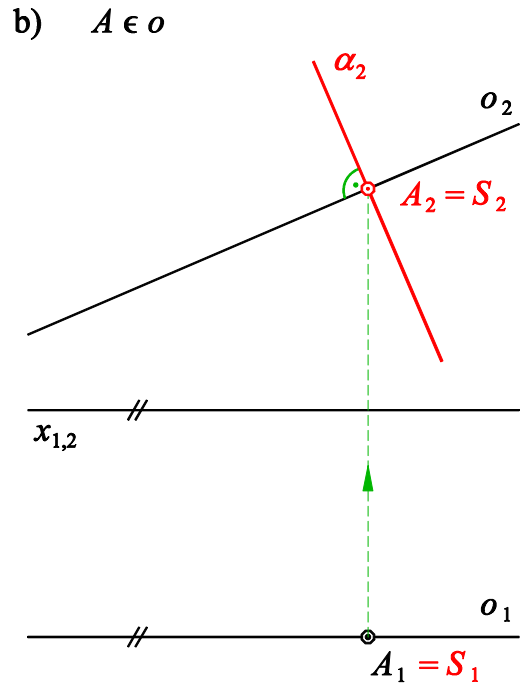
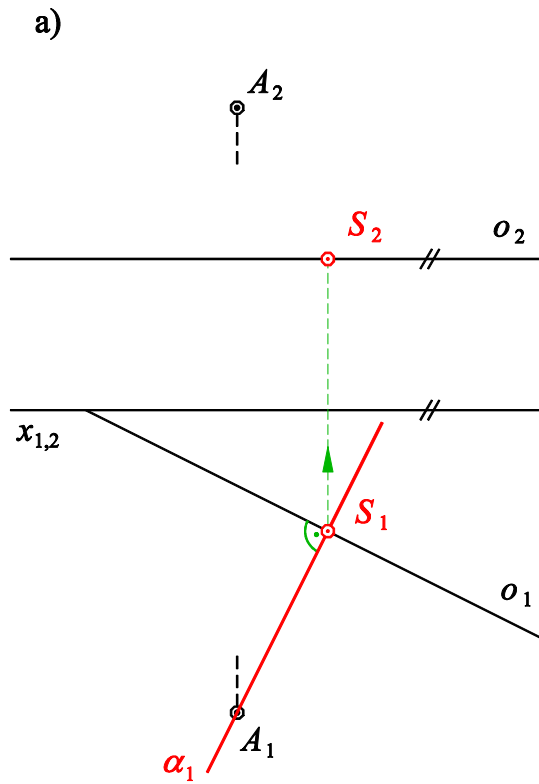

LIST 10

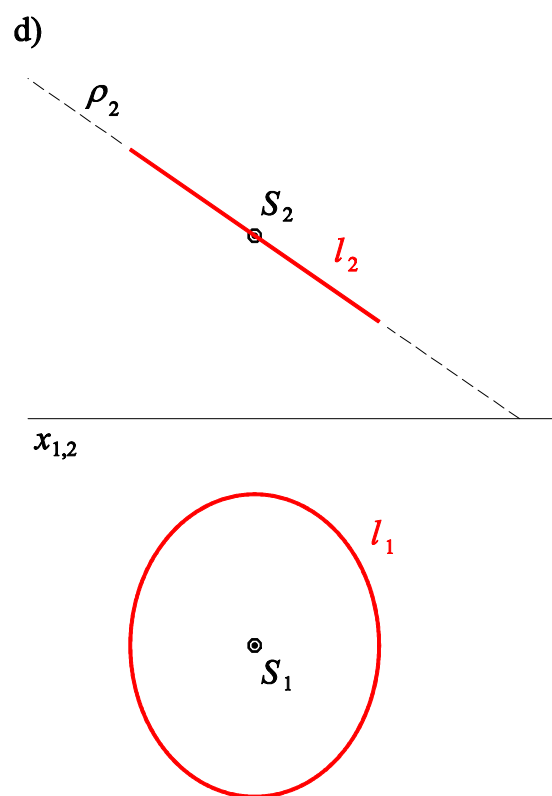
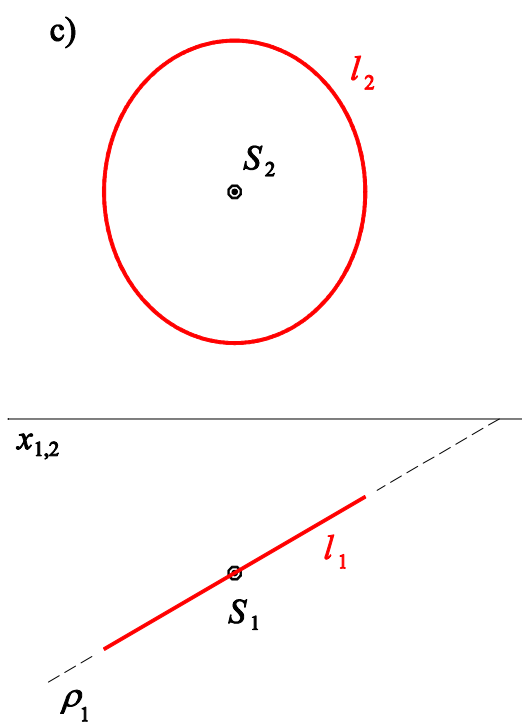
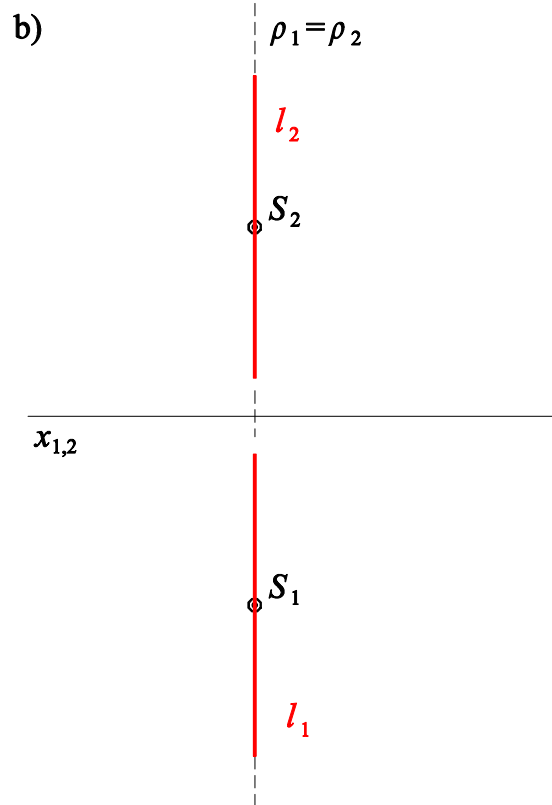
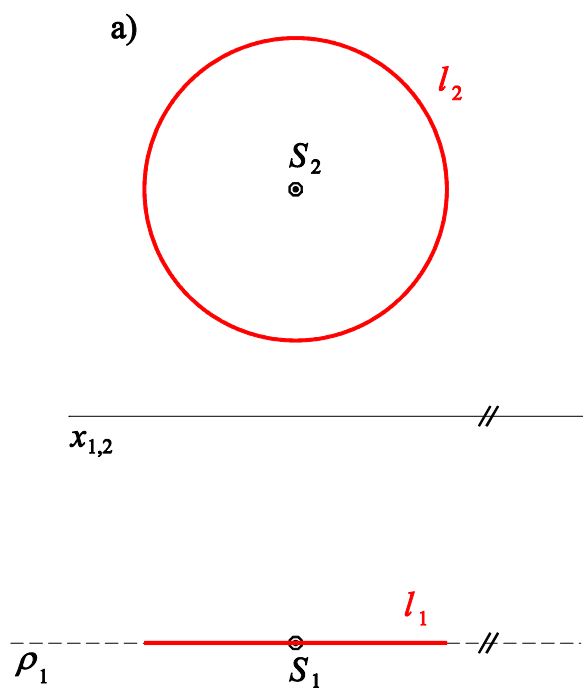

a)

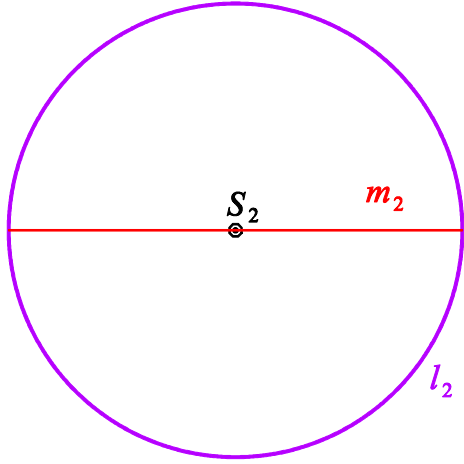

$x_{1,2}$

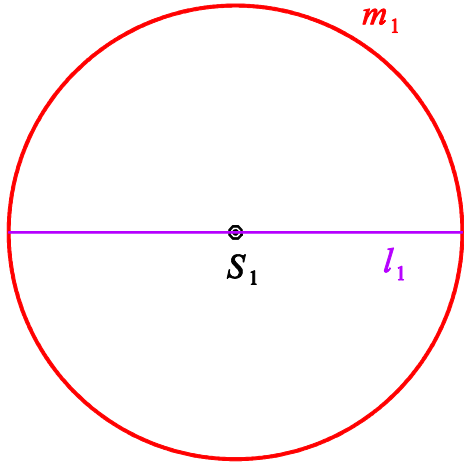

b)

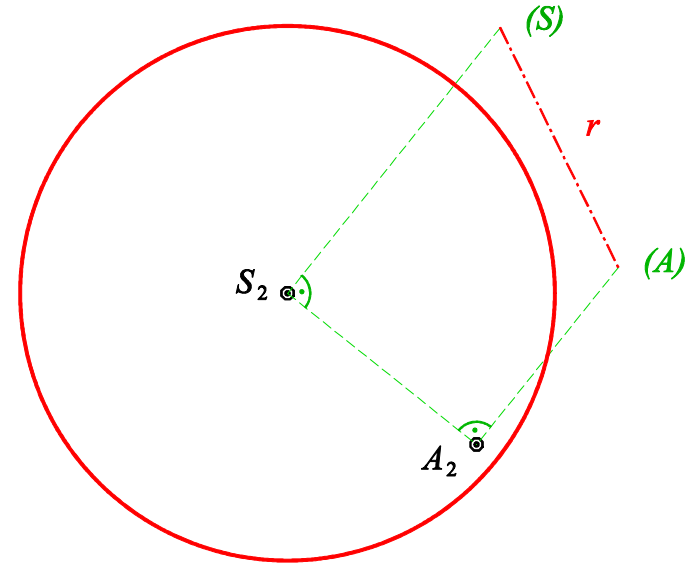

$x_{1,2}$

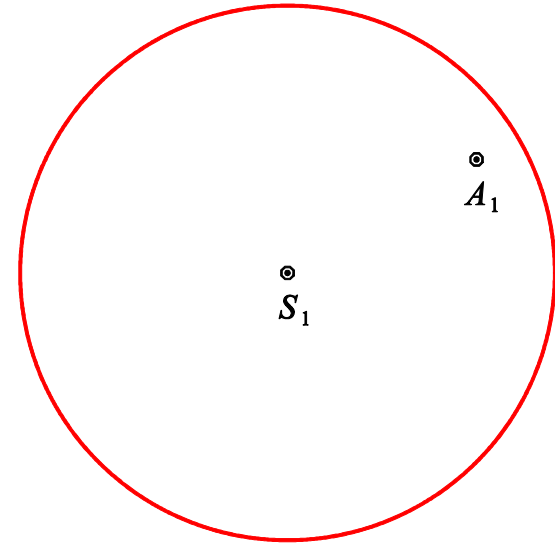

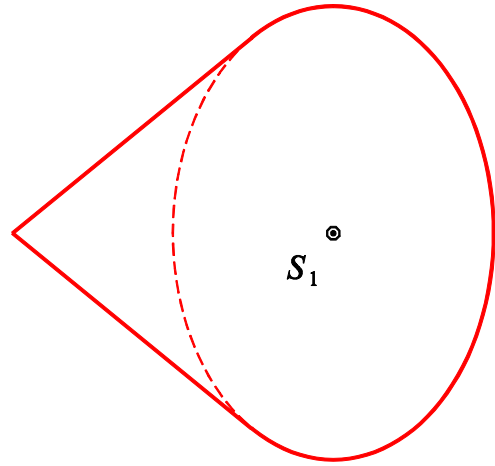
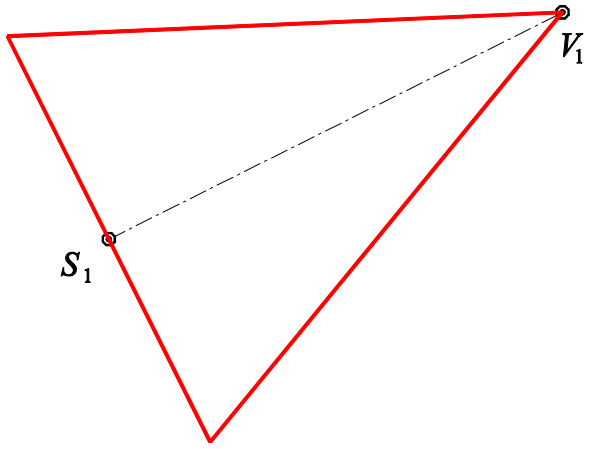
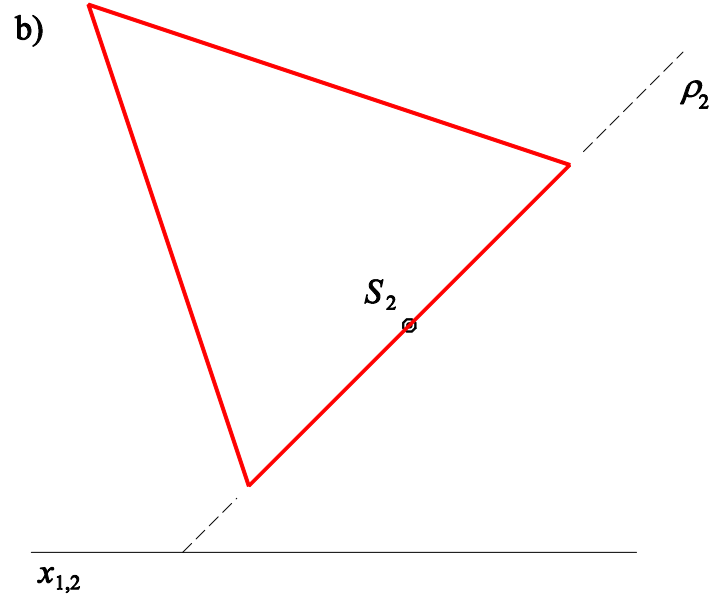
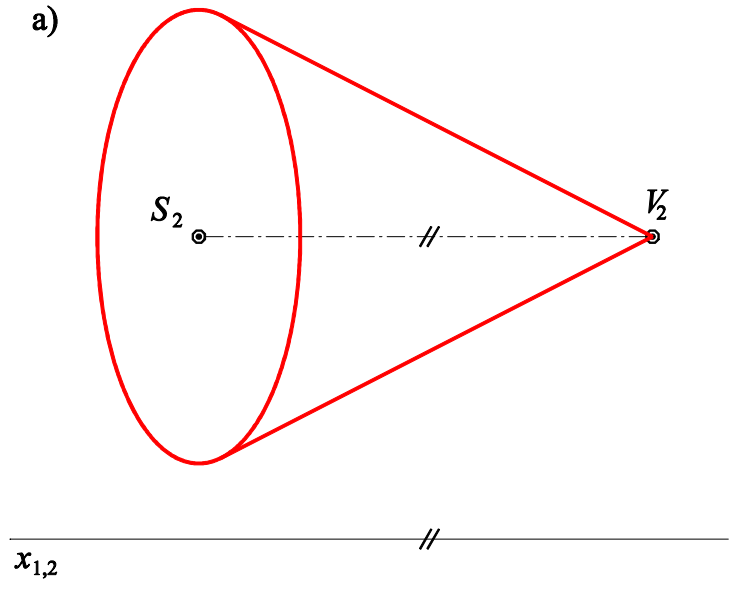

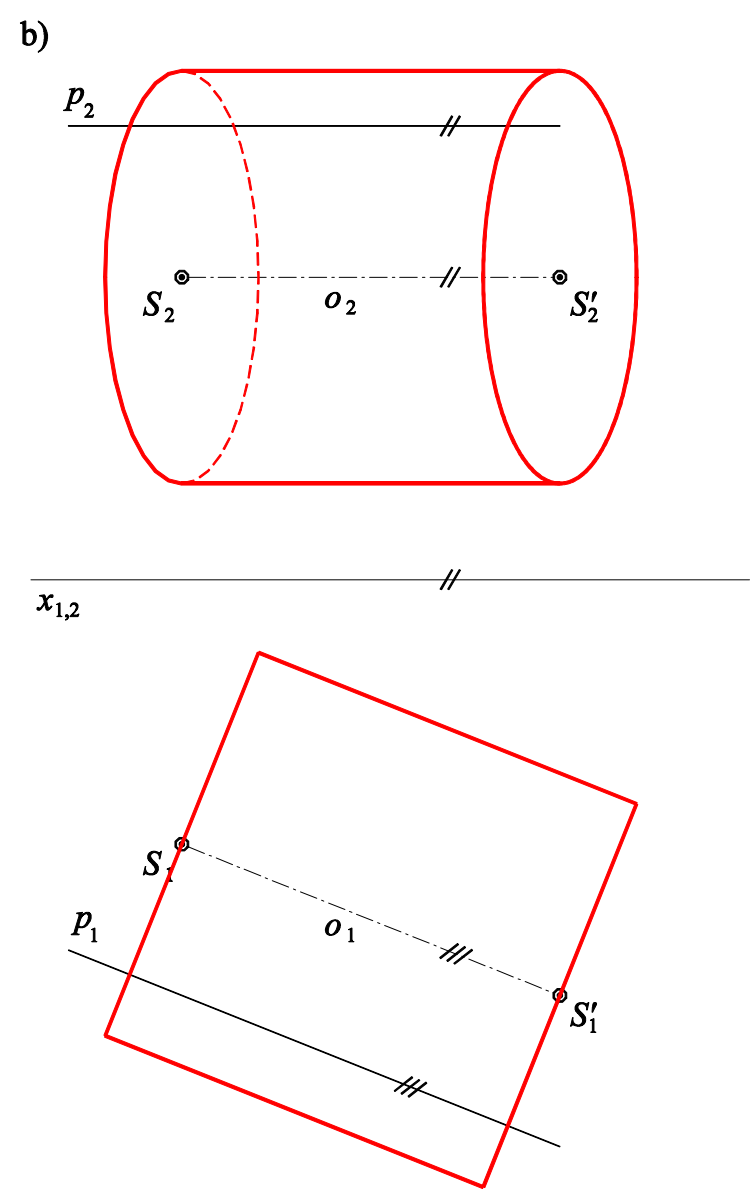
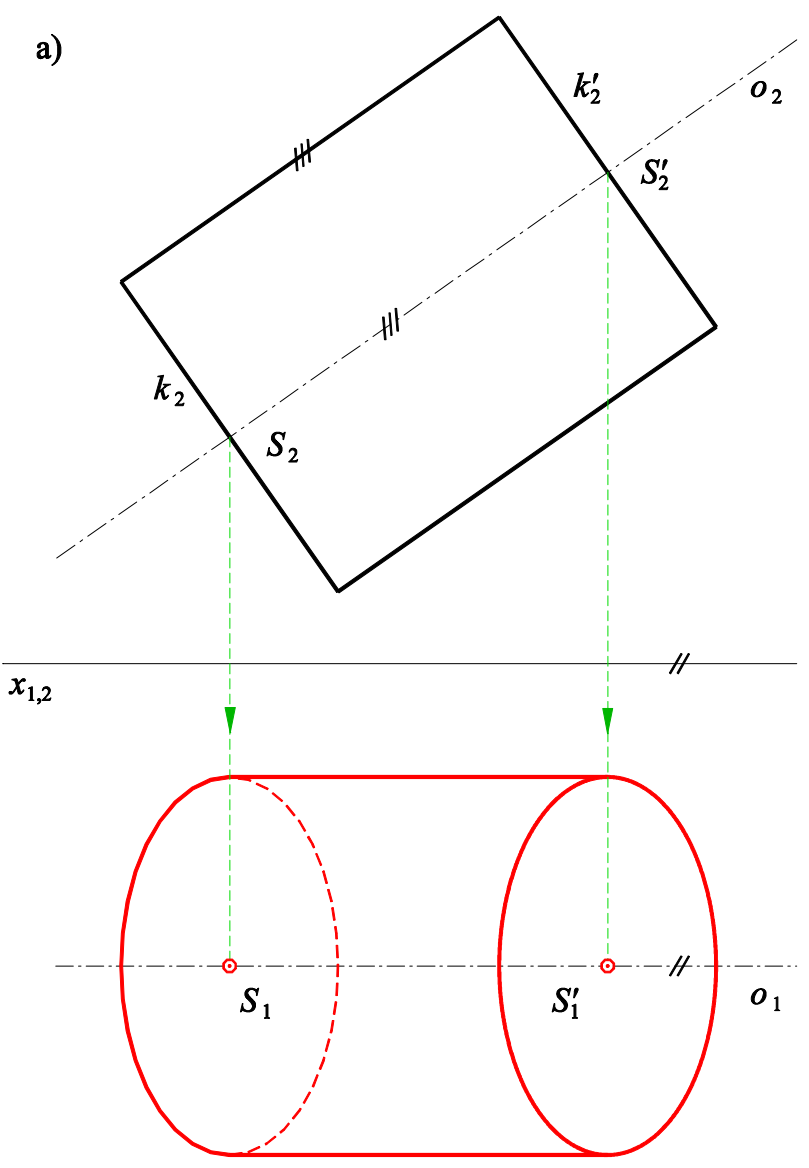

LIST 16

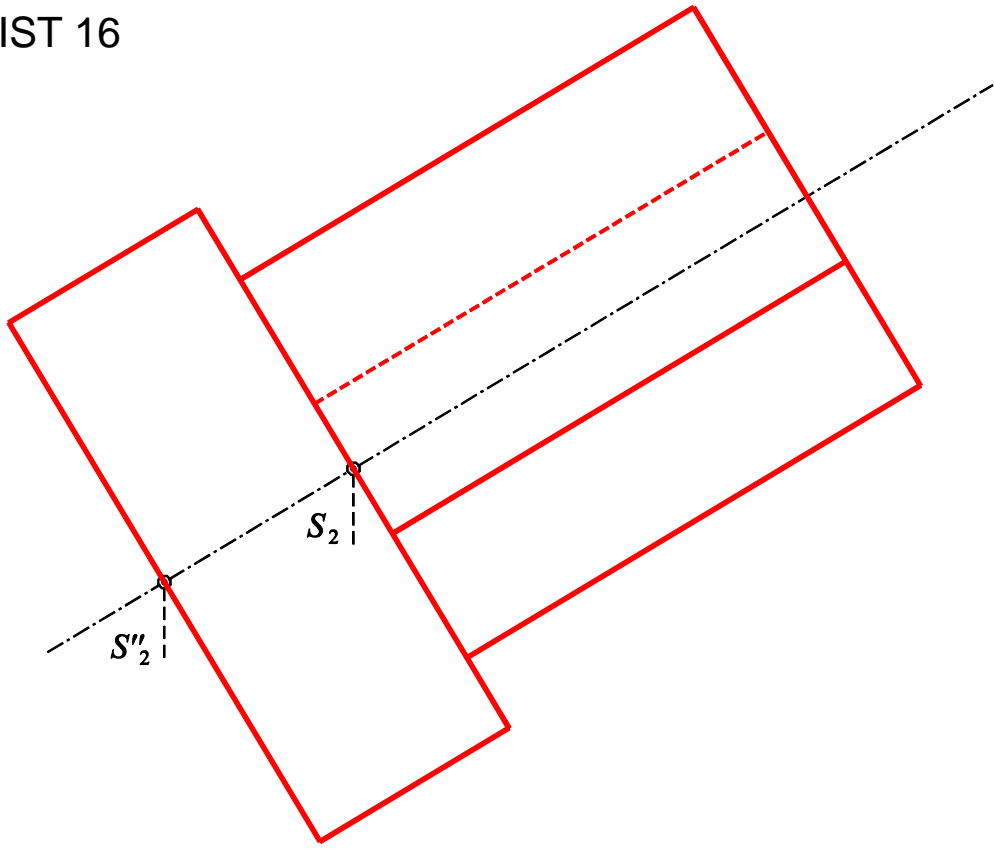

$x_{1,2}$

